



# Installation Instructions Parallel Arm Door Controls

## ASSA ABLOY

**CAUTION** An incorrectly installed or improperly adjusted door closer can cause property damage or personal injury. These instructions should be followed to avoid the possibility of misapplication or misadjustment. **CAUTION**

### Non Hold Open & Hold Open Models:

#### Series UNI-8300/UNI-8500

Available in sizes 2-3-4-5 or 6. Each power size can be increased by 50%.

#### Series UNI-8301/UNI-8501

Can be adjusted through a range of 1 through 6.

"H" suffix indicates Hold Open Arm  
 "DA" suffix (Delayed Action) is an optional feature.

### Standard Frame Installation

1-7/8 to 4-5/8  
 Frame Reveals  
 (Uses 6190 Bracket).  
 Bracket illustration page 4.  
 Door and frame preparation  
 See Page 2

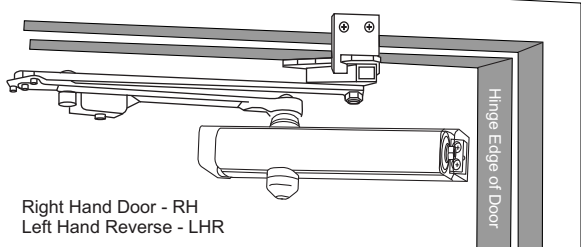

Right Hand Door - RH  
 Left Hand Reverse - LHR

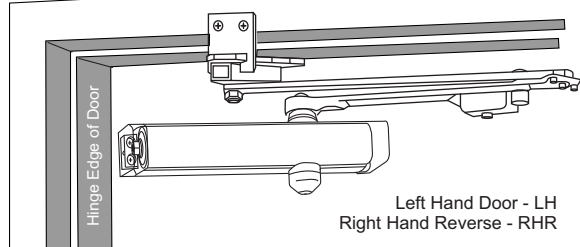

Left Hand Door - LH  
 Right Hand Reverse - RHR

### Deep Frame Installation

Frame Reveals Over 4-5/8  
 (Uses 6191 Clamp Kit).  
 Bracket illustration page 4.  
 Door preparation page 2  
 Frame preparation page 3

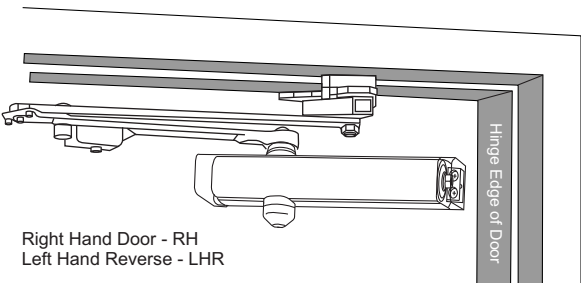

Right Hand Door - RH  
 Left Hand Reverse - LHR

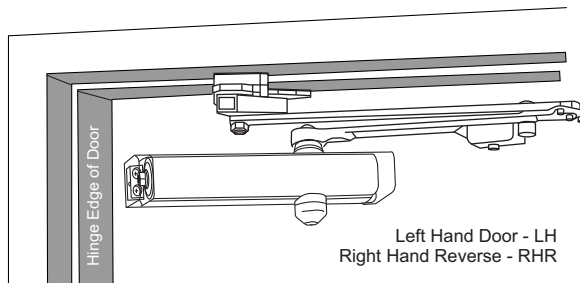

Left Hand Door - LH  
 Right Hand Reverse - RHR

### Flush Transom Installation

Flush Partitions  
 (Uses 2022 Bracket).  
 Bracket illustration page 4.  
 Door preparation page 2  
 Frame preparation page 3

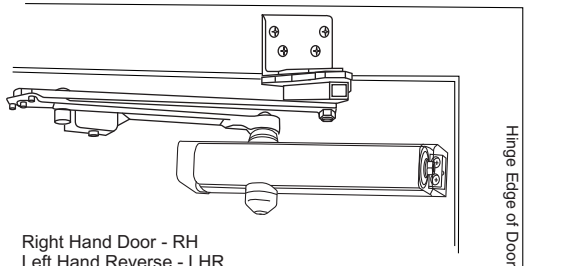

Right Hand Door - RH  
 Left Hand Reverse - LHR

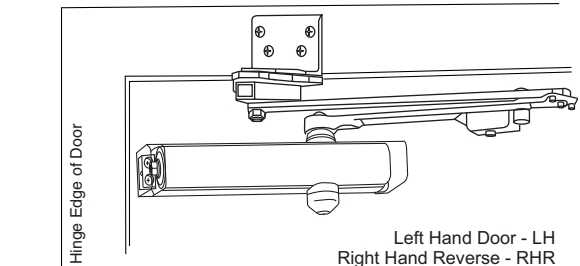

Left Hand Door - LH  
 Right Hand Reverse - RHR

**NOTE:** For special applications a separate door and frame preparation template is packed with these instructions

Use this instruction sheet for installation sequence and closer adjustments only

- It is recommended that the door on which the door closer will be installed be hung on ball bearing hinges. Door must swing freely
- Door and Frame must be properly reinforced, or use of special fasteners employed, to prevent the mounting screw from pulling out.
- All dimensions are given in inches with corresponding metric dimensions (mm) in parenthesis.

### Components:

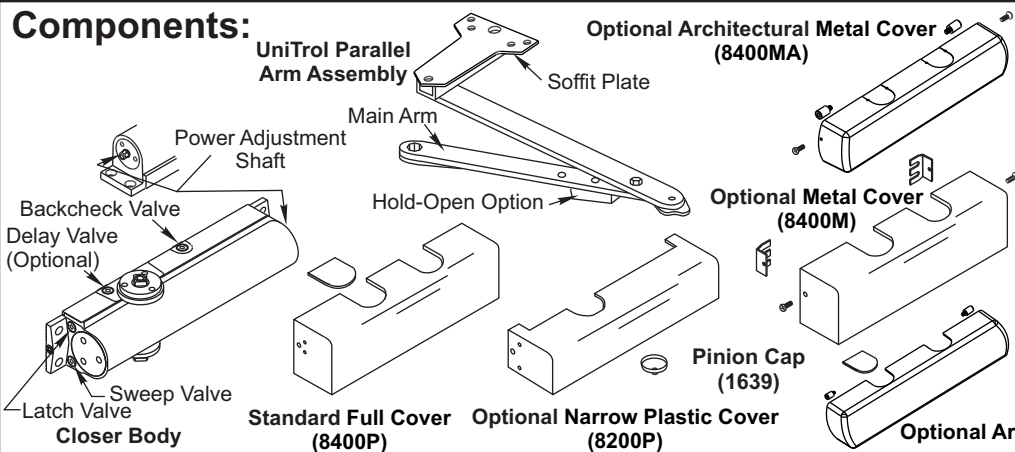

Arm Identification	Arm Stamping Arm Part Number	
	Non Hold Open	Hold Open
Door Width 28" - 32" (0.70 - 0.80m)	<b>6100-11</b> 11-6100-0235	<b>6100-1</b> 11-6100-0232
33" - 41" (0.85 - 1.00m)	<b>6100-13</b> 11-6100-0236	<b>6100-3</b> 11-6100-0233
42" - 48" (1.05 - 1.20m)	<b>6100-14</b> 11-6100-0237	<b>6100-4</b> 11-6100-0234

# Door Template Typical for All Installations

## Frame Template for 1-7/8 to 4-5/8 Reveals



ASSA ABLOY

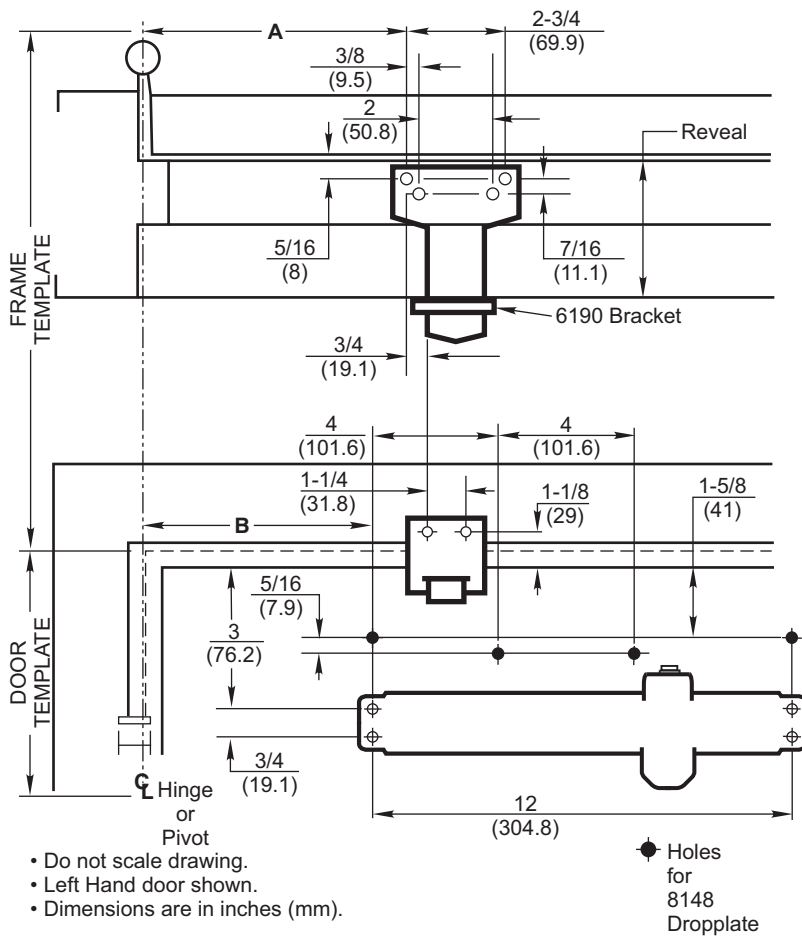

- Do not scale drawing.
- Left Hand door shown.
- Dimensions are in inches (mm).

- Door template is typical for all installations.
- Frame template must be selected according to frame reveal:

Inches	mm	Inches	mm	Inches	mm
5/16	7.9	3-1/4	83	8-7/8	225
3/8	9.5	3-5/8	90	9-1/4	235
7/16	11.1	4	101.6	9-3/4	248
1/2	12.7	4-3/8	111	10-1/8	257
3/4	19.1	4-1/2	114	10-3/8	264
1-1/8	29	4-7/8	124	10-1/2	267
1-1/4	31.8	5-1/8	130	11	279
1-1/2	38.1	5-1/4	133	11-1/2	292
1-5/8	41	5-3/4	146	12	305
1-3/4	44	6-1/4	159	12-1/8	308
1-7/8	48	6-3/4	171	12-1/2	318
2	50.8	7-1/8	181	12-3/4	324
2-1/8	54	7-1/2	191	13-5/8	346
2-1/2	63.5	7-5/8	194	14-1/4	362
2-3/4	69.9	8-1/8	206	15-1/8	384
2-7/8	73	8-1/4	210		
3	76	8-1/2	216		

• Holes for 8148 Dropplate

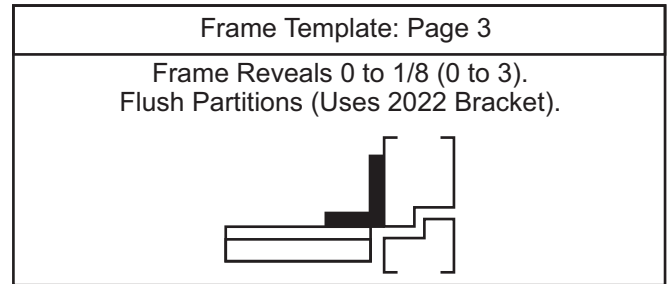
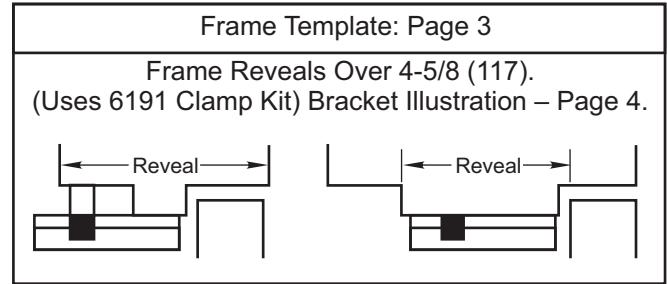
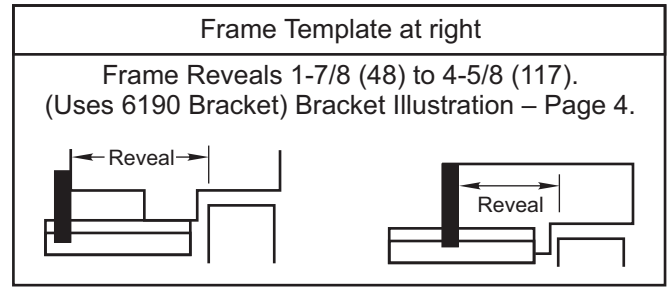

Preparation for Fasteners			
	Fasteners	Door or Frame	Drill-Sizes
Standard	Self-Drilling Screw	Aluminum or Metal	No drill required
		Wood	3/16" (4.30 mm)
	1/4" - 20 machine screw	Metal	Drill: #7 (0.201" dia.) Tap: 1/4" - 20
Optional	Sleeve nuts and bolts	Hollow Metal	9/32" (7 mm) through; 3/8" (9.5 mm) door face opposite to closer
		Aluminum or Wood	3/8" (9.5 mm) through
	Through-bolts and grommet-nuts	All	9/32" (7 mm); 3/8" (9.5 mm) dia. x 3/8" (9.5 mm) deep on door opposite to closer

Dimensions for Doors 28" to 32" Wide					
Opening		Dimension A		Dimension B	
Hold Open	Stop	Inches	mm.	Inches	mm.
85°	90°	10-3/8	264	5-1/8	130
90°	95°	9-3/4	248	4-1/2	114
95°	100°	9-1/4	235	4	102
100°	105°	8-7/8	225	3-5/8	92
105°	110°	8-1/2	216	3-1/4	83
110°	115°	8-1/8	206	2-7/8	73

Dimensions for Doors 33" to 41" Wide					
Opening		Dimension A		Dimension B	
Hold Open	Stop	Inches	mm.	Inches	mm.
85°	90°	12-3/4	324	7-1/2	191
90°	95°	12	305	6-3/4	171
95°	100°	11-1/2	292	6-1/4	159
100°	105°	11	279	5-3/4	146
105°	110°	10-1/2	267	5-1/4	133
110°	115°	10-1/8	257	4-7/8	124

Dimensions for Doors 42" to 48" Wide					
Opening		Dimension A		Dimension B	
Hold Open	Stop	Inches	mm.	Inches	mm.
85°	90°	15-1/8	384	9-3/4	248
90°	95°	14-1/4	362	8-7/8	225
95°	100°	13-5/8	346	8-1/4	210
100°	105°	13	330	7-5/8	194
105°	110°	12-1/2	318	7-1/8	181
110°	115°	12-1/8	308	6-3/4	171

# Frame Template for Reveals Over 4-5/8 Door Template on Page 2



ASSA ABLOY

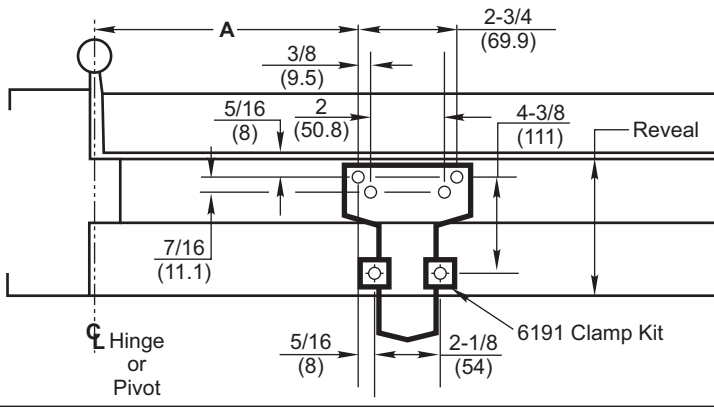

## Typical Installation

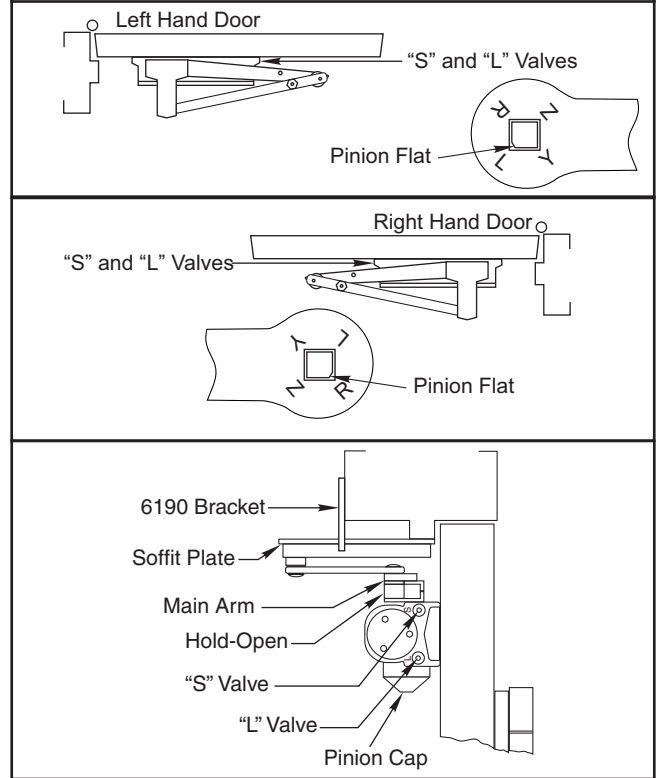

# Frame Template for Flush Partitions Door Template on Page 2

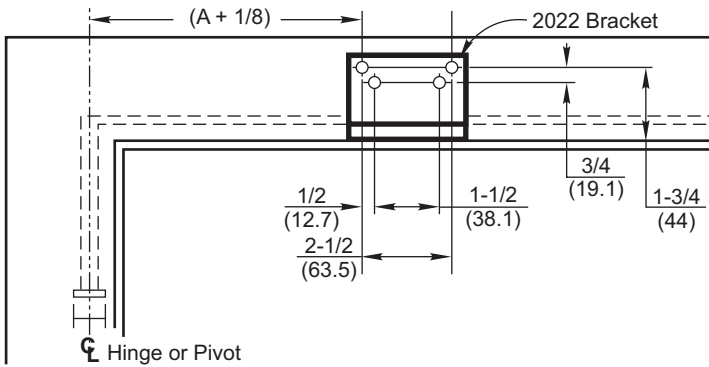

## Installation Sequence

- **Read Front Page.**  
Installations and component identification are on this page. Arm assembly must be correct for width of door, see chart.
- **Select Correct Door and Frame Template Combination.**  
Follow "Template Information" on Page 2 or Pages 2 and 3.
- **Mark Location of Mounting Holes.**  
Use dimensions for hold-open or door stop angle desired. Mark position of 4 holes on door for closer (or drop plate) and 6 holes on frame for soffit plate (or 4 for 2022 angle bracket).
- **Prepare Holes for Fasteners.**  
See chart on Page 2.
- **Set closer average power.**  
For multi-size closers only, use "Power Setting-Multisize Closers" chart on page 4.
- **Mount Closer to Door.**  
Dropplate first, if used. Place end with "S" and "L" valves toward the lock edge of the door. (Slip clips for optional full metal cover, 8400M, under closer feet, if this cover is used.)
- **Mount Arm to Frame.**  
Fasten soffit plate (or 2022 angle bracket if flush partition) to frame. Mount 6190 bracket or 6191 clamps to reinforce soffit plate. Or fasten 2022 bracket to frame and then soffit plate to 2022 bracket.

- **Install Arm on Pinion Shaft.**  
Close valves "S" and "L". Rotate pinion over 45° to align main arm letter "R" (right hand) or "L" (left hand) with pinion flat. Fasten with arm screw. See "Typical Installation" figure above right. Re-open valves "S" and "L".
  - **Adjust Closer.**  
See "Unit Adjustment" on Page 4.
  - **Install Cover and Pinion Cap, if required.**  
**8400 Full Cover:** Slide cover insert into the un-used cutout in cover. Install cover using screws provided.  
**8200P Narrow Cover:** Install cover using screws provided. Install pinion cap onto pinion shaft by hand or with a Phillips screw driver - DO NOT OVER TIGHTEN.  
**8400M Full Metal Cover:** Fasten cover to mounting clips with screws provided.  
**8400MA Metal Architectural Cover:** Remove cover insert where pinion is located. Install standoffs in ends of closer. Install cover using screws provided.  
**8400A Plastic Architectural Cover:** Slide cover insert into the un-used cutout in cover. Install standoffs in ends of closer. Snap cover over standoffs.
- NOTE:** Architectural Covers CAN NOT be used for doors swinging over 120° using parallel mount.

# Unit Adjustment

## Closing Speed Controls

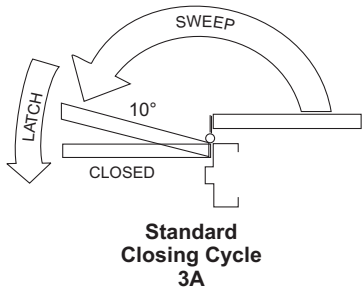

**CAUTION:**  
DO NOT BACK VALVES OUT OF CLOSER  
OR A LEAK WILL RESULT.

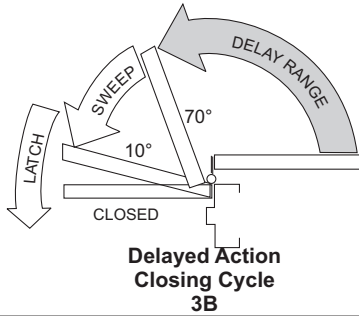

## Opening Door Control

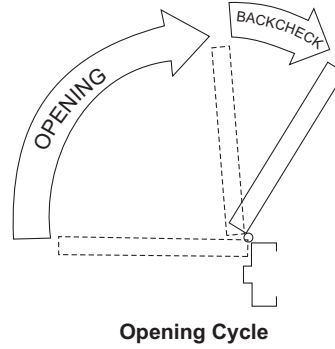

**CAUTION:**  
DO NOT BACK VALVES OUT OF CLOSER  
OR A LEAK WILL RESULT.

**NOTE:** By law the Americans with Disabilities Act (ADA) may require that door closer installation comply with accessibility guidelines.

## Closing Speed Controls

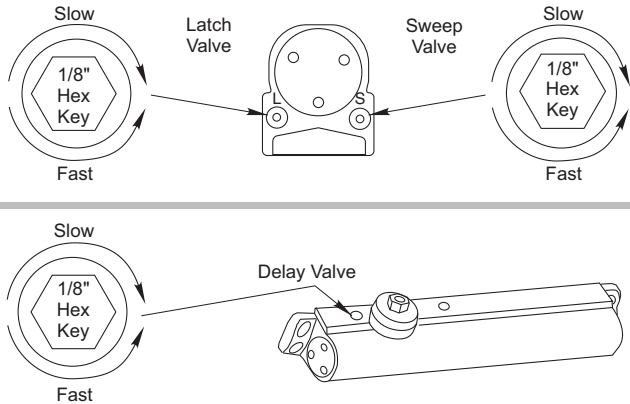

## Backcheck Control

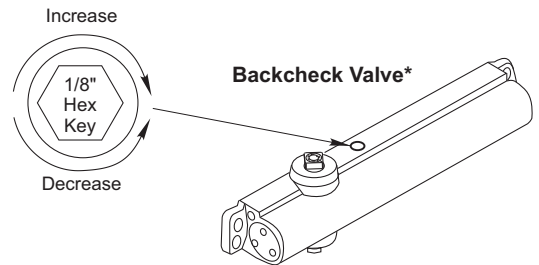

\* NEVER close this valve completely.

## Closing Power Control

Use 5/16" socket or adjustable wrench for adjustment.

To increase power turn Spring Adjustment Shaft clockwise. A total of 20 360° turns of the nut will provide maximum power.

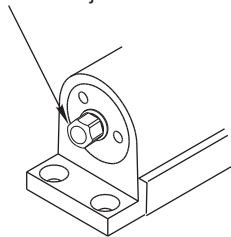

## Power Adjustment Chart (Multi Size Closers)

DOOR	PARALLEL ARM INSTALLATION	*	MAXIMUM DOOR SIZE			
			28-32" (0.70-0.80 m)	33-41" (0.85-1.00 m)	42-48" (1.05-1.20 m)	Max # of turns
INT	<b>UNI-8301/ UNI-8501</b>	FULL 360° TURNS OF POWER ADJUSTMENT SHAFT	7	10	16	20
EXT			9	12	18	20

\*20 -360° TURNS MAXIMUM AVAILABLE

## Door Holder Option

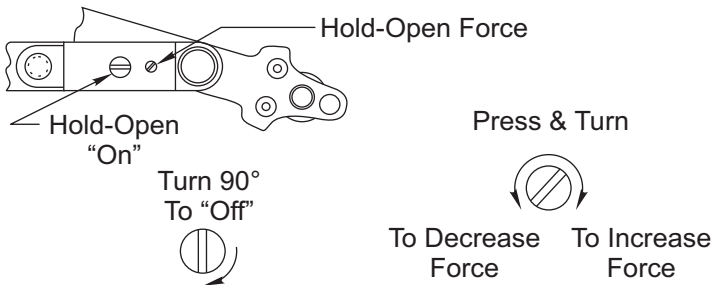

**Hold-Open** option is found at the arm elbow. To select hold-open "on" or hold-open "off" and to adjust the hold-open force ... use screwdriver as illustrated.

## Bracket Illustrations

Standard 6190 Bracket



Deep Reveal Option

Flush Partition Option

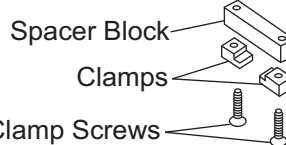

4 Bracket Screws

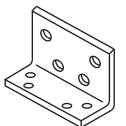

**No. 6191 Reinforcing Kit**

**No. 2022 Bracket**

**Norton**  
**ASSA ABLOY**

3000 Highway 74 East • Monroe, NC 28112  
Tel: (877)-974-2255 • Fax: (800)-338-0965  
www.nortondoorsolutions.com